

Worksheet

11/05/2019

Free on dw-math.com

Problem quickname: 5518

1)

Complete the shape by drawing the missing lines. Use solid lines for lines that are visible, dashed or dotted lines for lines that are invisible or obscured.

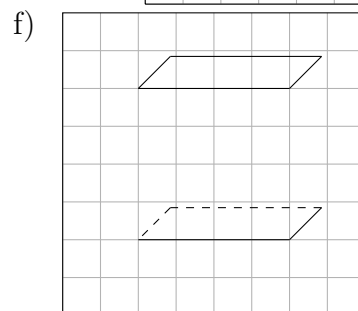
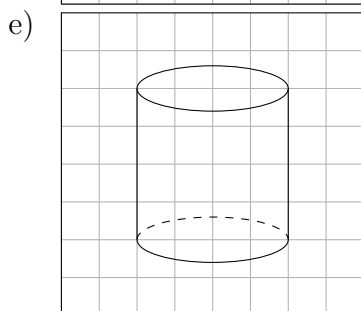
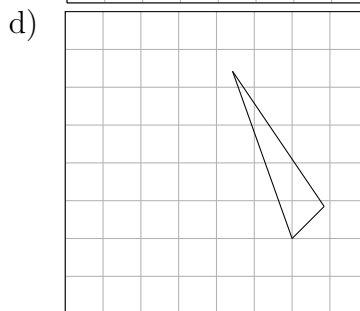
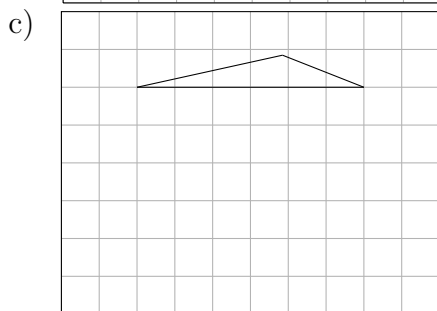
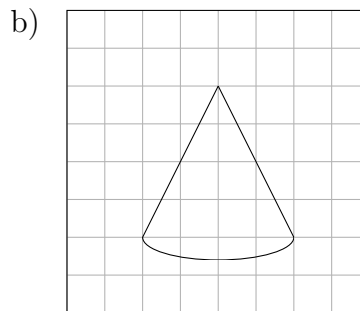
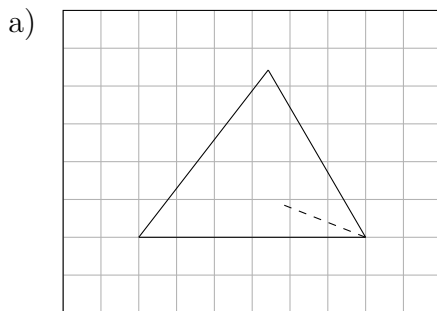

2)

Complete the shape by drawing the missing lines. Use solid lines for lines that are

visible, dashed or dotted lines for lines that are invisible or obscured.

a) Shape: A cube

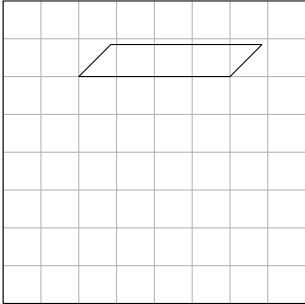

b) Shape: A prism

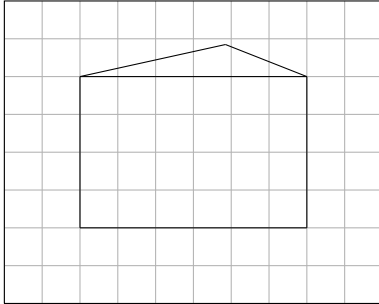

c) Shape: A cylinder

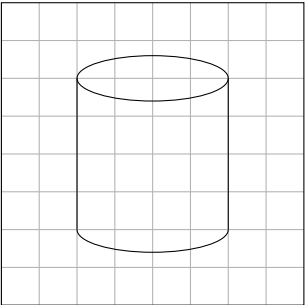

d) Shape: A tetrahedron

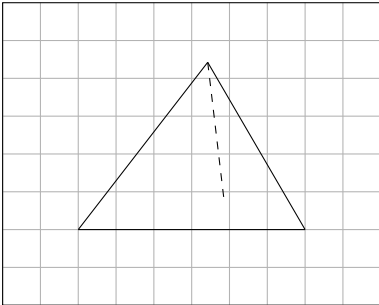

e) Shape: A pyramid

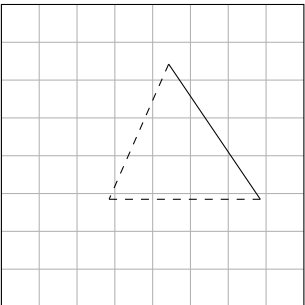

f) Shape: A cuboid

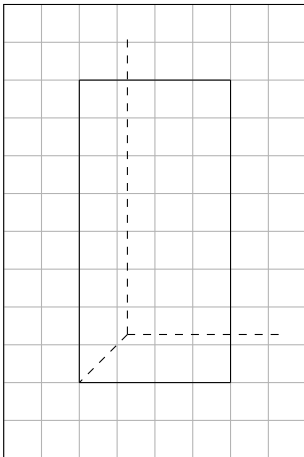

3)

Complete the shape by drawing the missing lines. Use solid lines for lines that are

visible, dashed or dotted lines for lines that are invisible or obscured.

a) Shape: A pyramid

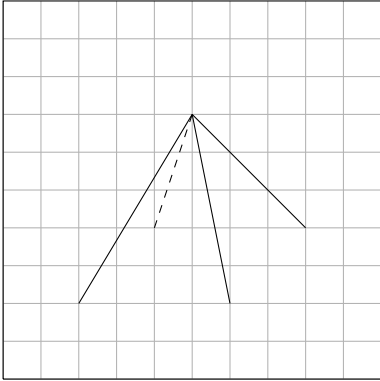

b) Shape: A cuboid

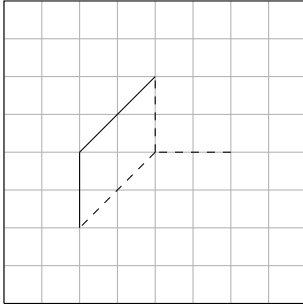

c) Shape: A cuboid

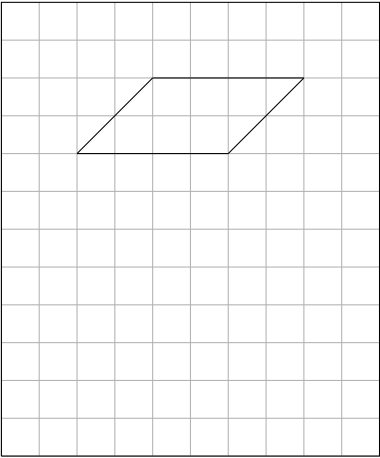

d) Shape: A cone

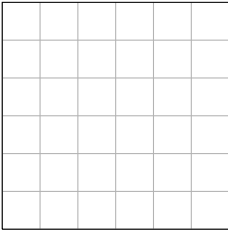

4)

Complete the shape by drawing the missing lines. Use solid lines for lines that are visible, dashed or dotted lines for lines that are invisible or obscured.

a) Shape: A pyramid

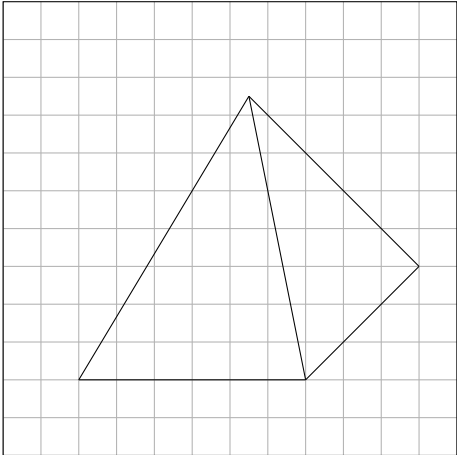

b) Shape: A cone

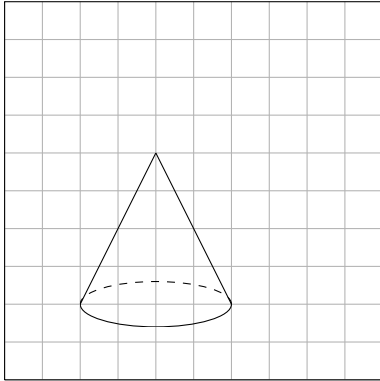

c) Shape: A cylinder

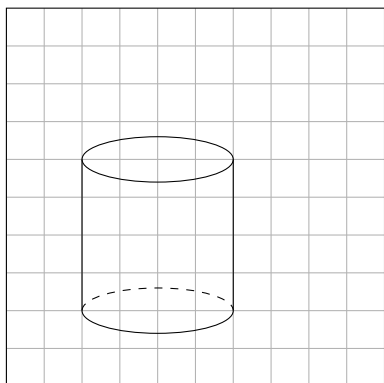

Good Luck!