

Worksheet

06/06/2018

Free on dw-math.com

Problem quickname: 5247

1)

Shade the indicated portion of each shape.

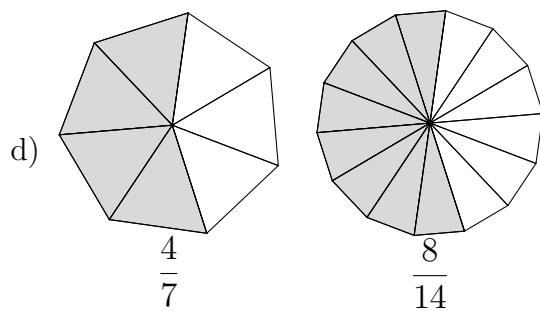
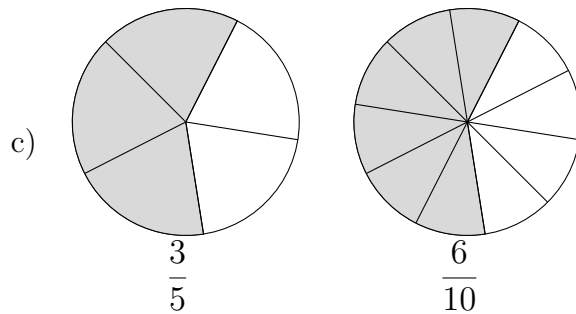
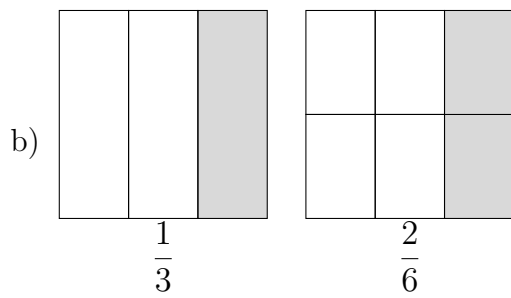
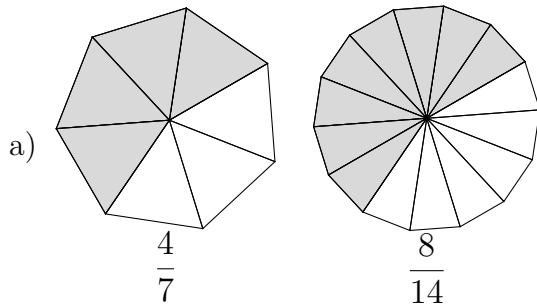
Quick:
5247

2)

Quick:
5247

Shade the indicated portion of each shape.

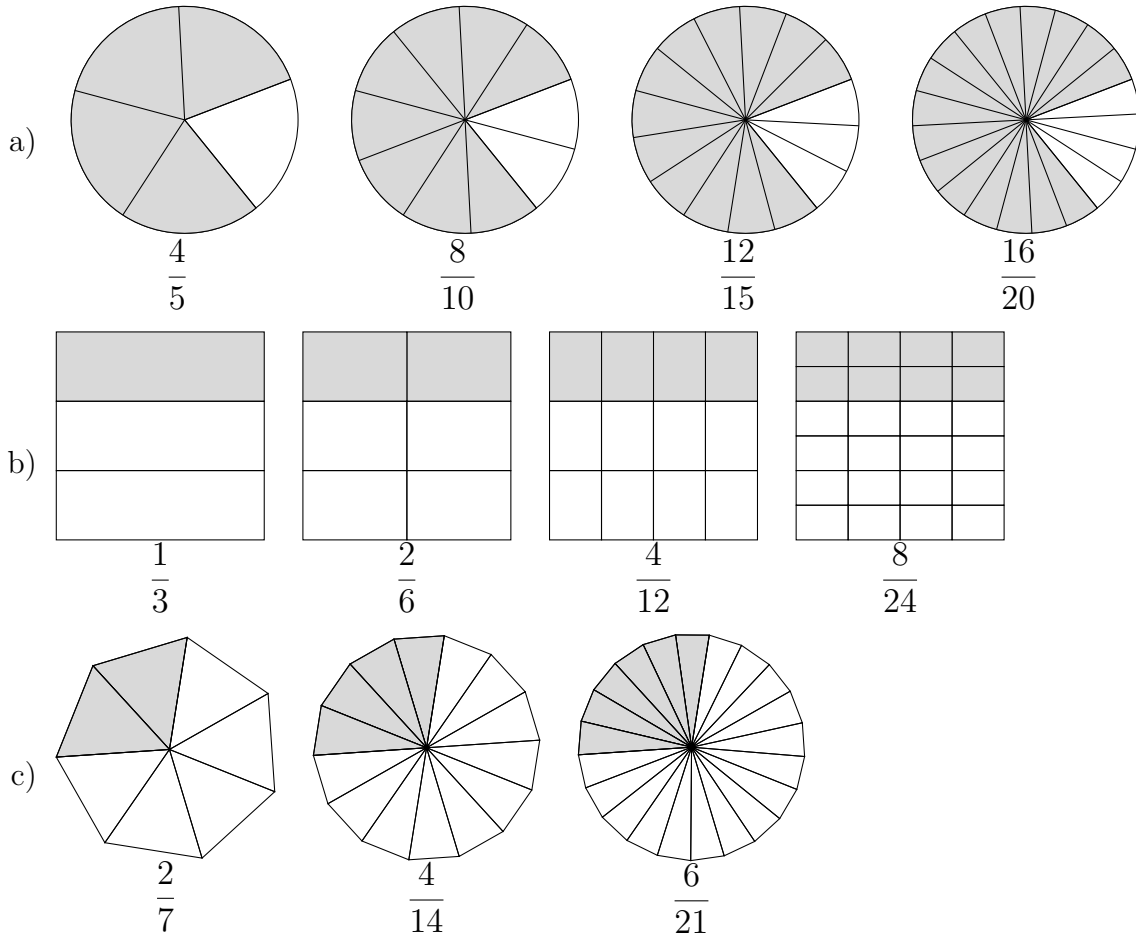

3)

Quick:
5247

Shade the indicated portion of each shape.

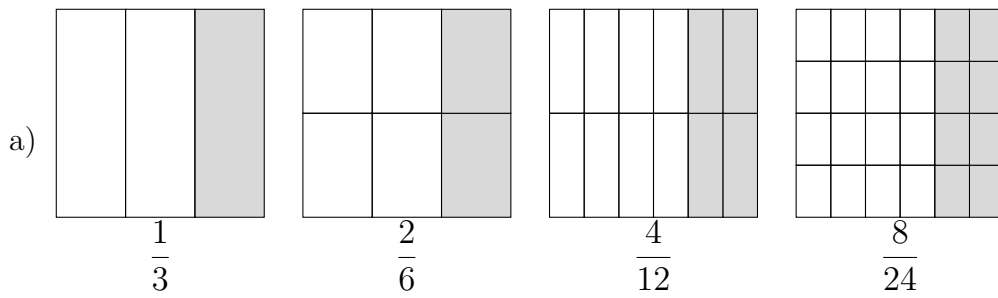

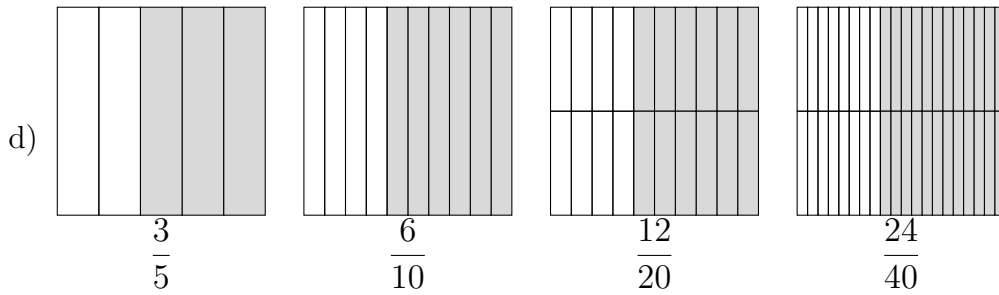
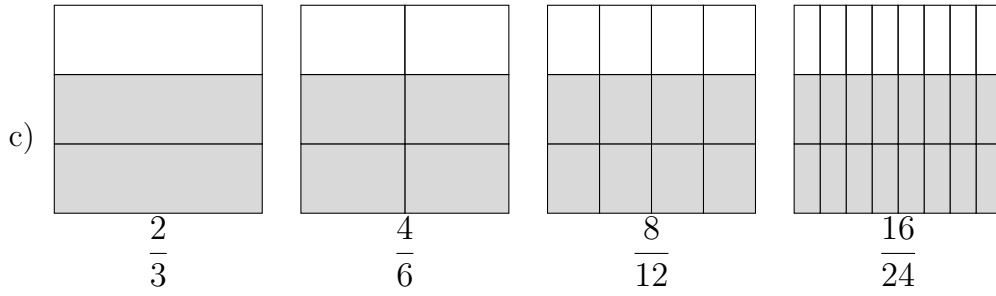
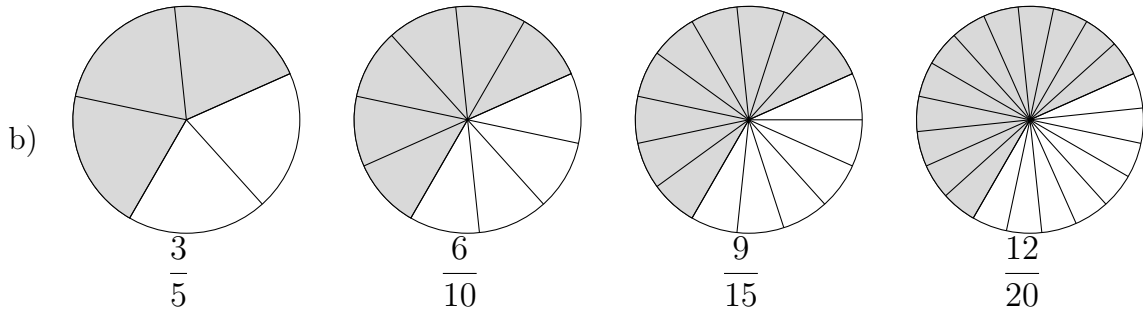

4)

Shade the indicated portion of each shape.

Quick:
5247

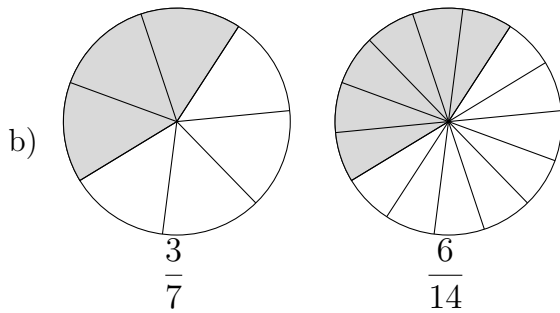
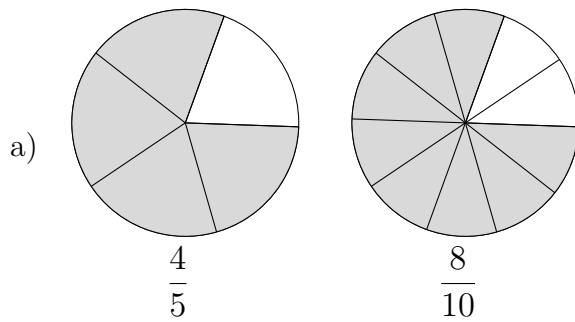

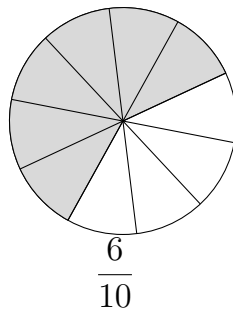
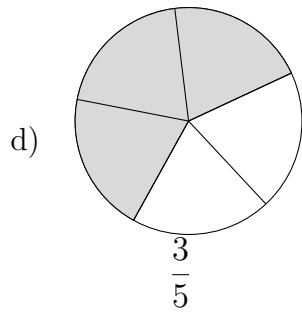
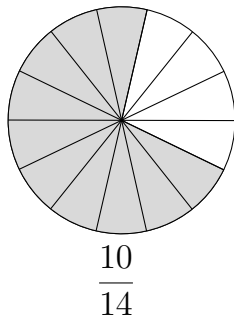
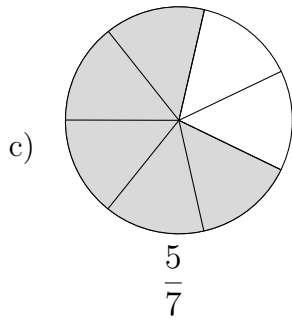

Good Luck!