

Worksheet

05/05/2020

Free on dw-math.com

Problem quickname: 9522

1)

Draw a picture of the three-dimensional geometric shape in perspective.

Quick:
9522

a) A pyramid.

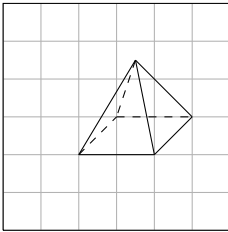

b) A cylinder.

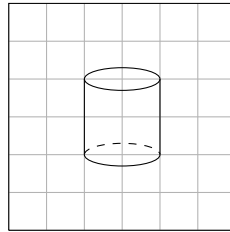

c) A cuboid.

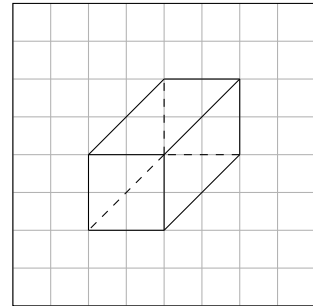

d) A cube.

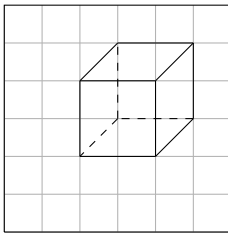

2)

Draw a picture of the three-dimensional geometric shape in perspective.

Quick:
9522

a) A cone.

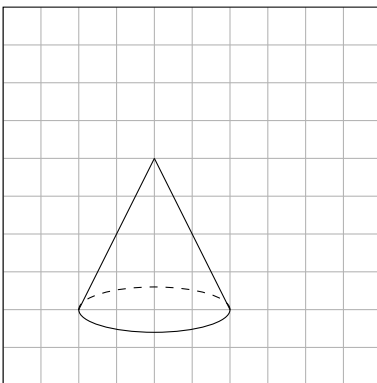

b) A cylinder.

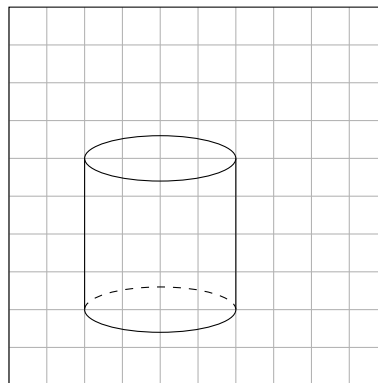

c) A cuboid.

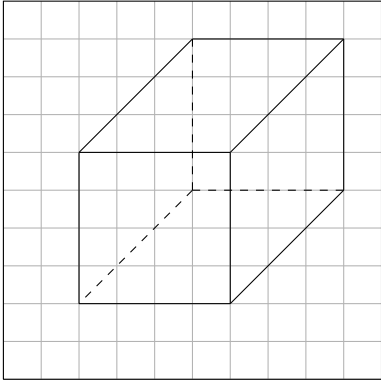

d) A tetrahedron.

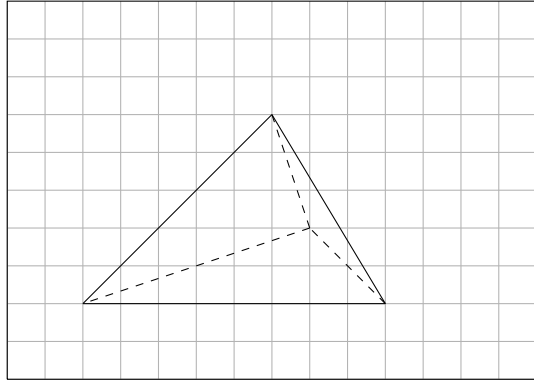

3)

Draw a picture of the three-dimensional geometric shape in perspective.

Quick:
9522

a) A cylinder.

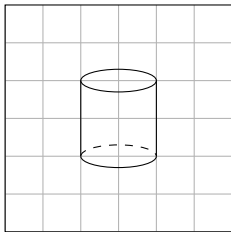

b) A tetrahedron.

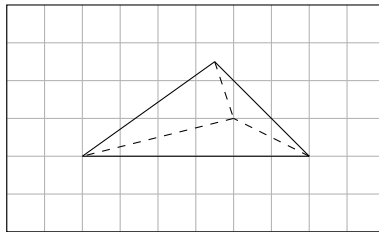

c) A pyramid.

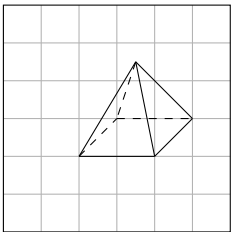

d) A cuboid.

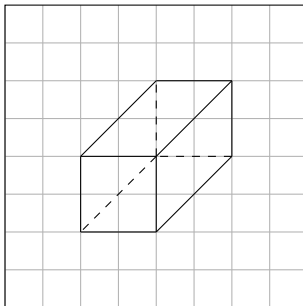

4)

Quick:
9522

Draw a picture of the three-dimensional geometric shape in perspective.

a) A pyramid.

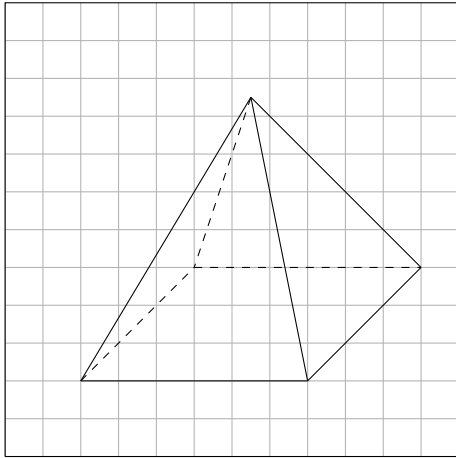

b) A cone.

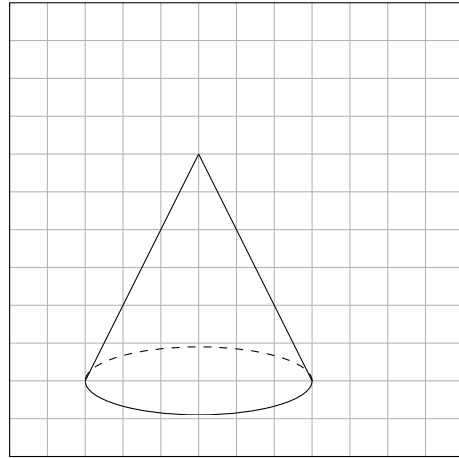

Good Luck!