

# Worksheet

04/27/2018

Free on dw-math.com

Problem quickname: 3289

1)

Draw the mirror image to complete the shape. Use the mirror line.

Quick:  
3289

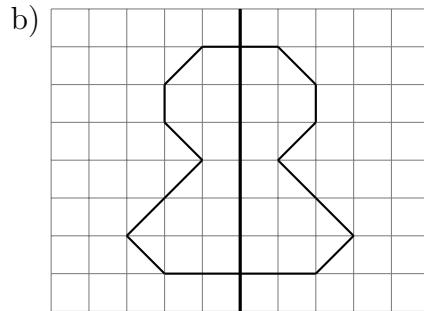
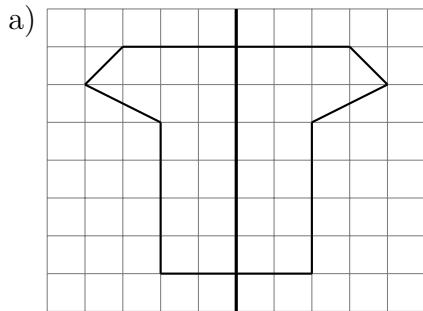

2)

Draw the mirror image to complete the shape. Use the mirror line.

Quick:  
3289

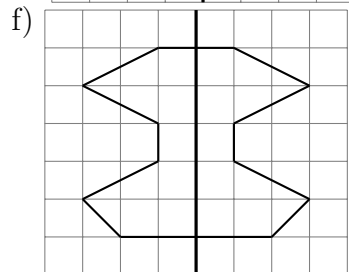
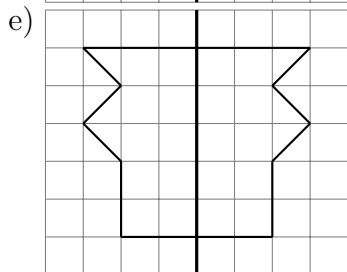
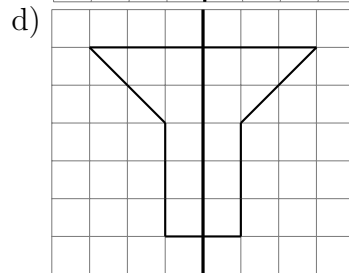
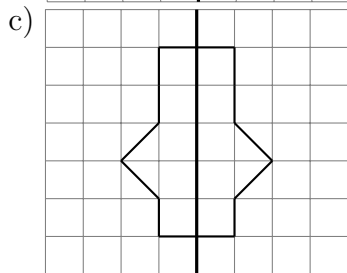
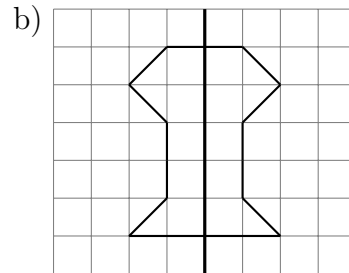
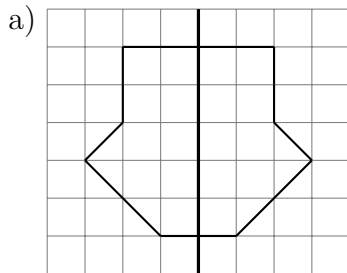

3)

Quick:  
3289

Draw the mirror image to complete the shape. Use the mirror line.

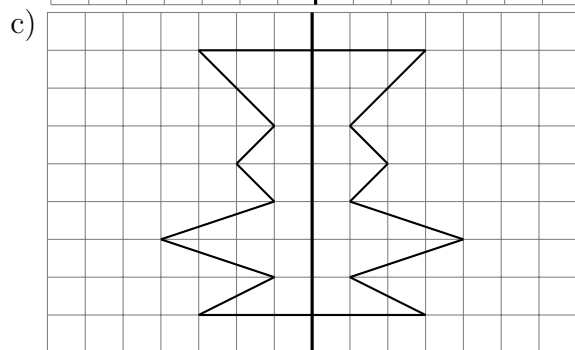
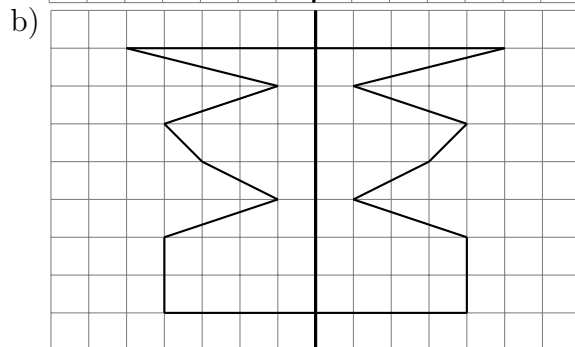
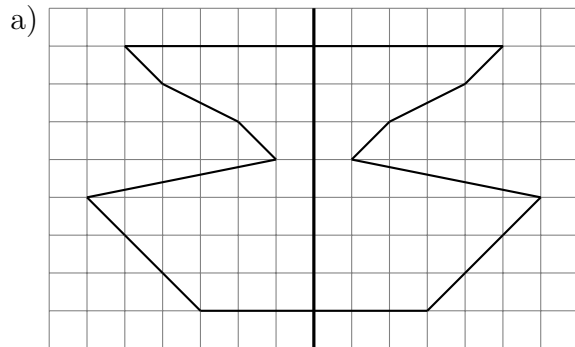

4)

Quick:  
3289

Draw the mirror image to complete the shape. Use the mirror line.

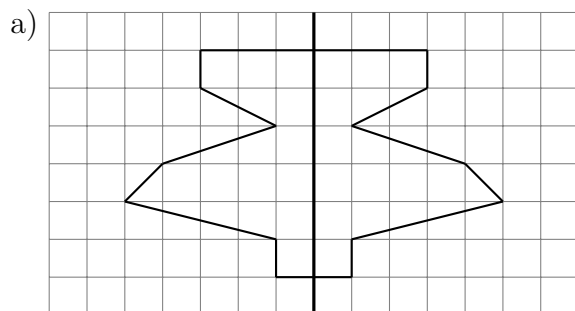

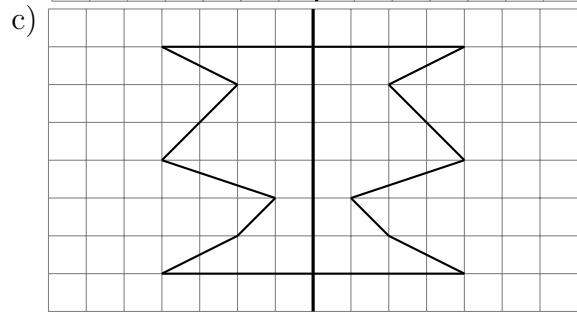
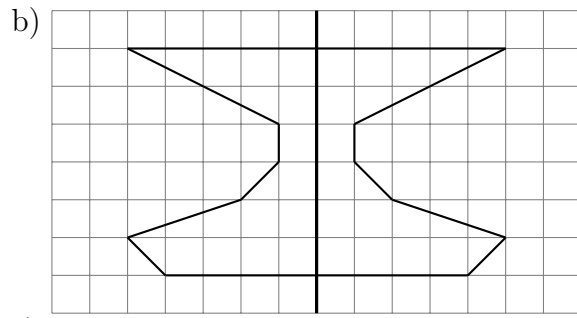

Good Luck!