

Worksheet

06/02/2021

Free on dw-math.com

Problem quickname: 1443

1)

Complete the shape by drawing the missing invisible lines. Use a dotted or dashed line.

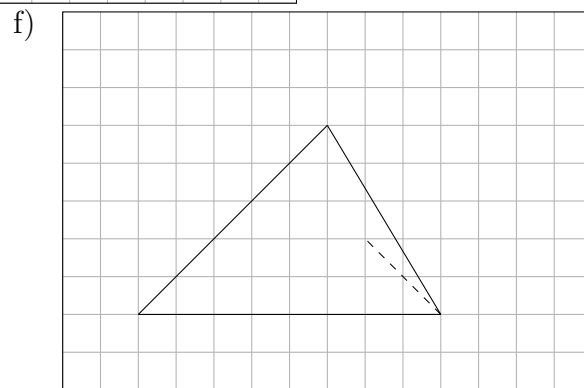
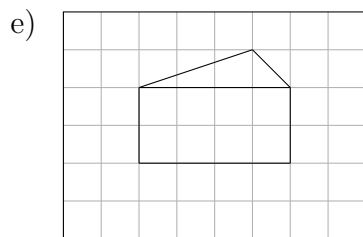
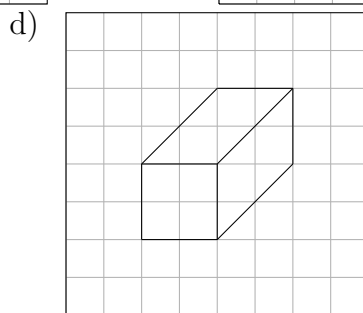
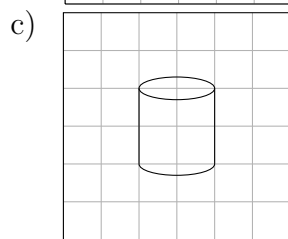
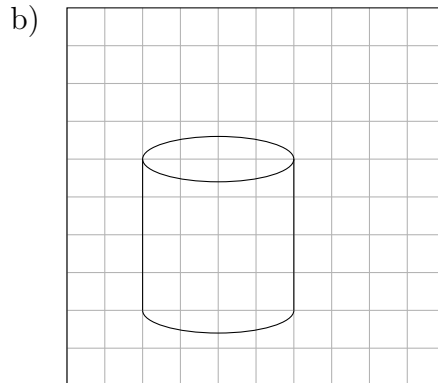
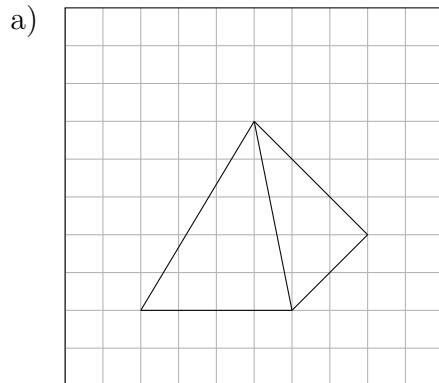

2)

Complete the shape by drawing the missing invisible lines. Use a dotted or dashed line.

a)

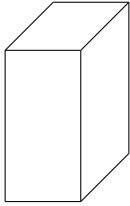

b)

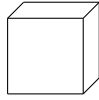

c)

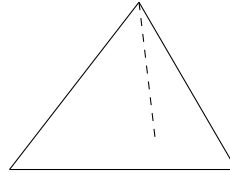

d)

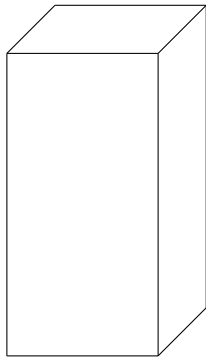

e)

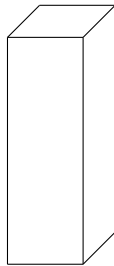

f)

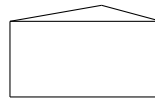

3)

Complete the shape by drawing the missing invisible lines. Use a dotted or dashed line.

a) Shape: A cylinder

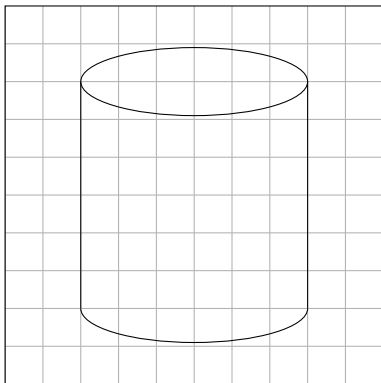

b) Shape: A cuboid

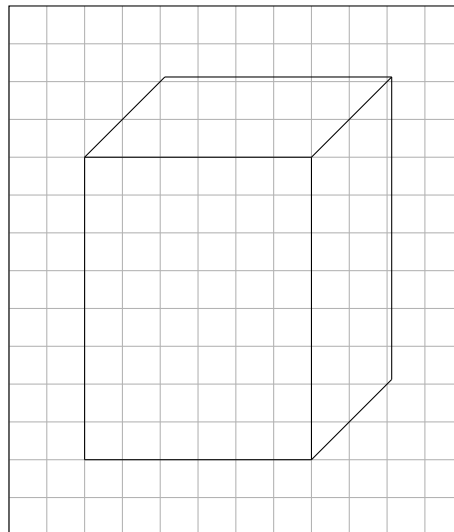

c) Shape: A cone

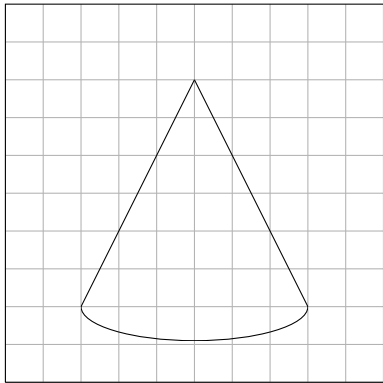

4)

Complete the shape by drawing the missing invisible lines. Use a dotted or dashed line.

a) Shape: A cube

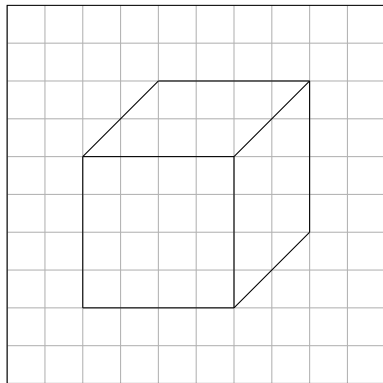

b) Shape: A cuboid

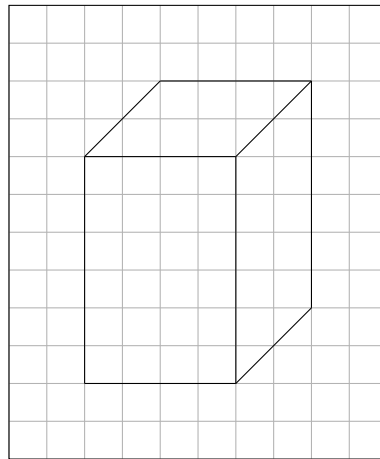

c) Shape: A pyramid

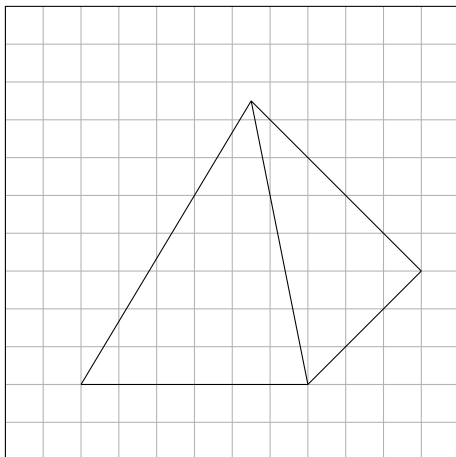

Good Luck!