

Worksheet

06/02/2021

Free on dw-math.com

Problem quickname: 1443

1)

Complete the shape by drawing the missing invisible lines. Use a dotted or dashed line.

a) Shape: A cuboid

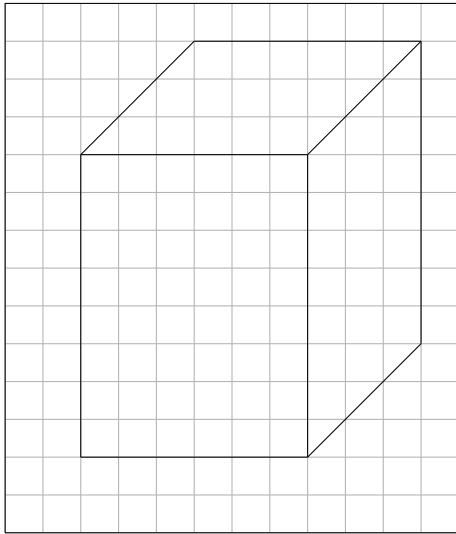

b) Shape: A cube

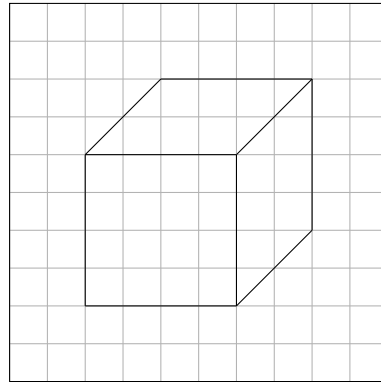

c) Shape: A cube

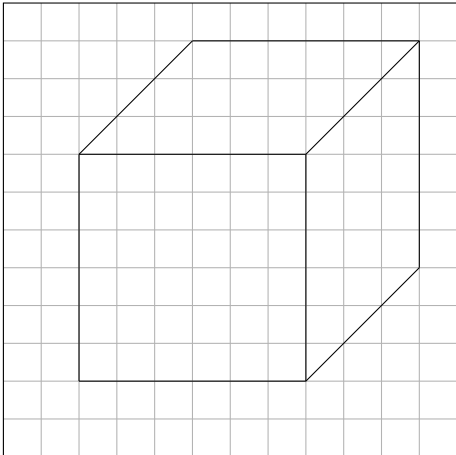

2)

Complete the shape by drawing the missing invisible lines. Use a dotted or dashed line.

a) Shape: A pyramid

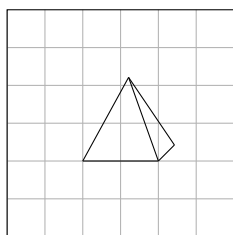

b) Shape: A prism

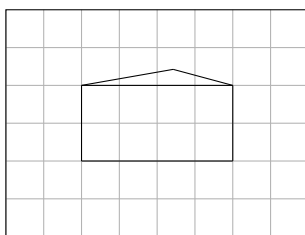

c) Shape: A cylinder

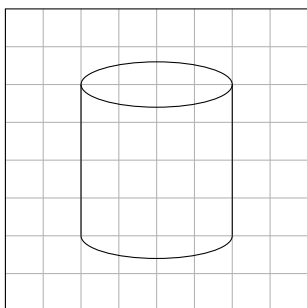

d) Shape: A prism

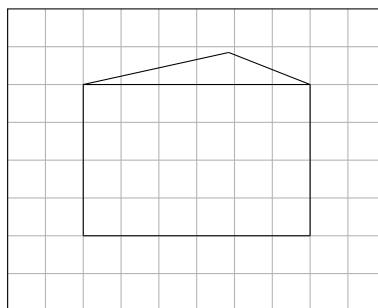

3)

Complete the shape by drawing the missing invisible lines. Use a dotted or dashed line.

a)

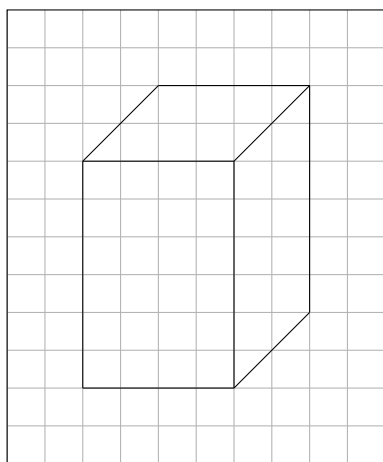

b)

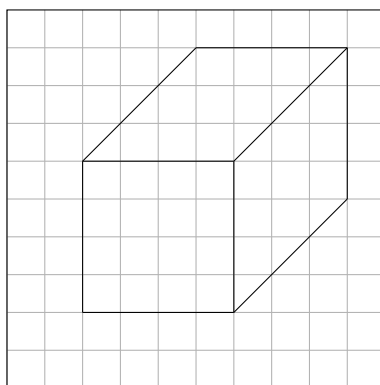

c)

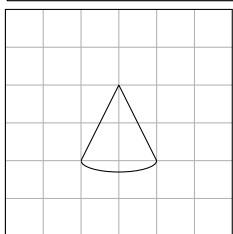

d)

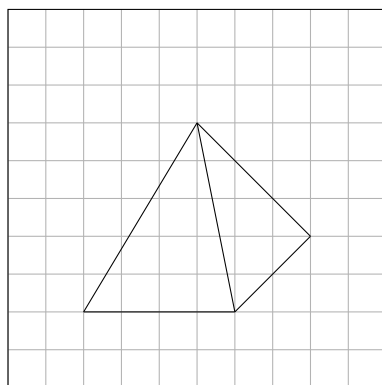

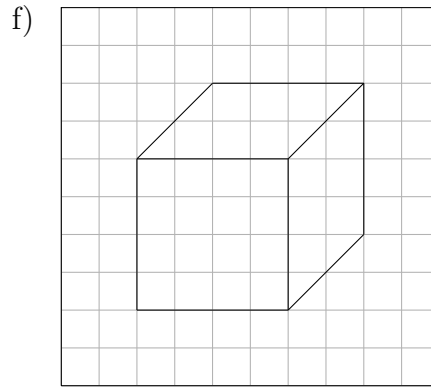
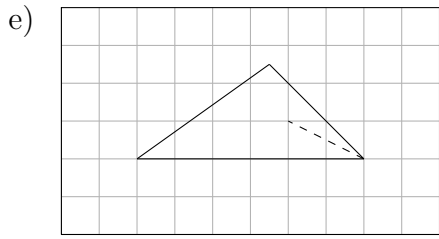

4)

Complete the shape by drawing the missing invisible lines. Use a dotted or dashed line.

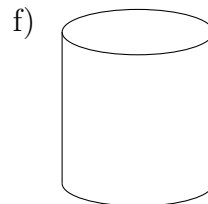
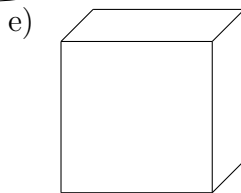
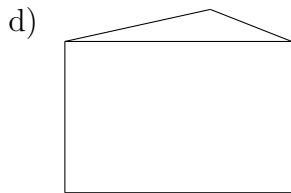
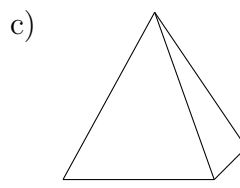
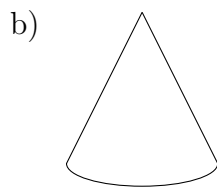
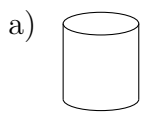

Good Luck!