

Worksheet

11/03/2019

Free on dw-math.com

Problem quickname: 5978

1)

Name the geometric shape that is shown.

a)

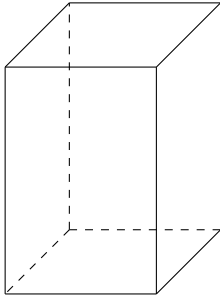

b)

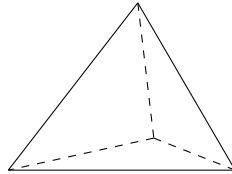

c)

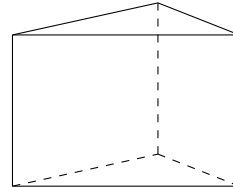

d)

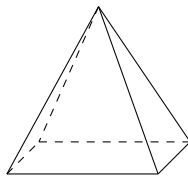

e)

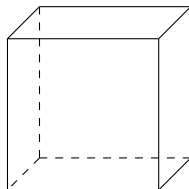

f)

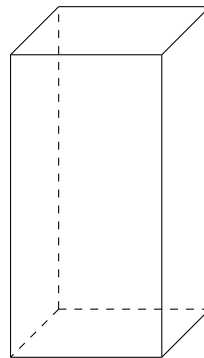

2)

Name the geometric shape that is shown.

a)

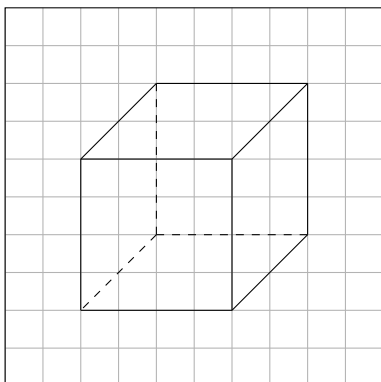

b)

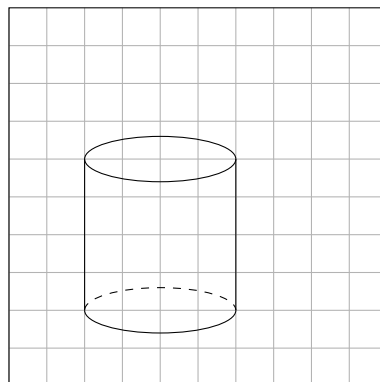

c)

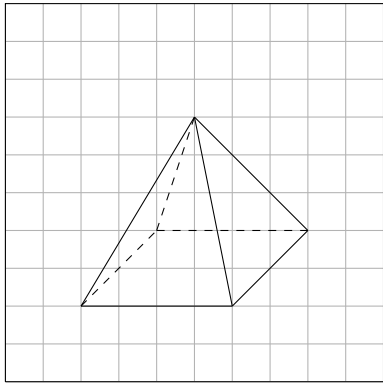

3)

Name the geometric shape that is shown.

a)

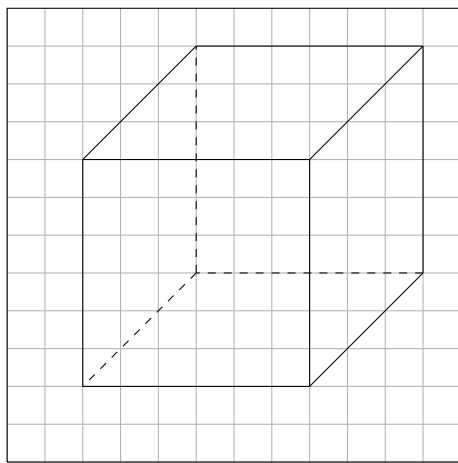

b)

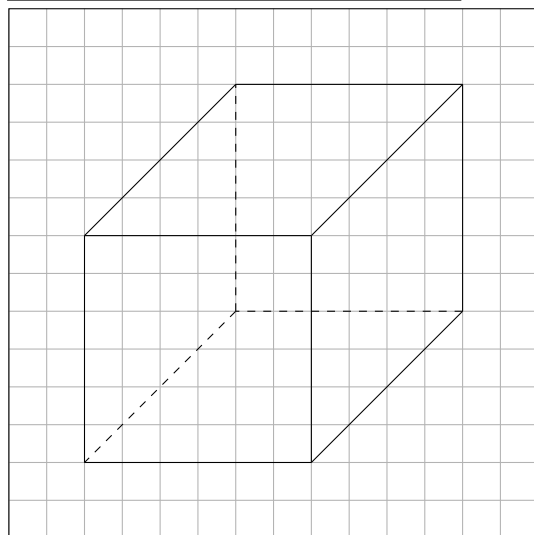

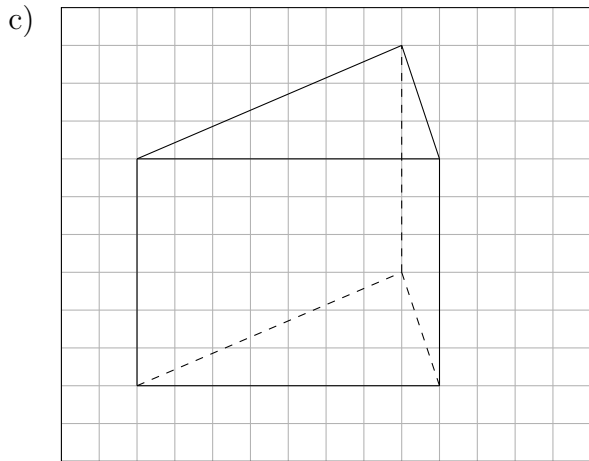

4)

Name the geometric shape that is shown.

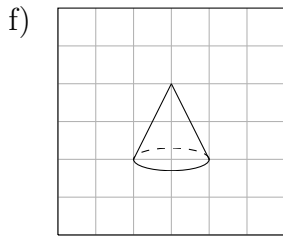
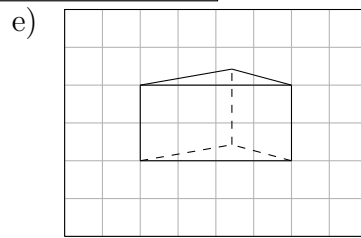
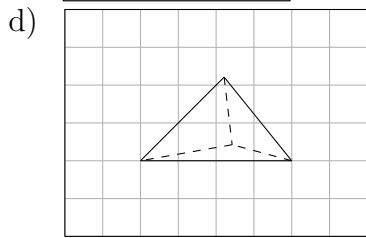
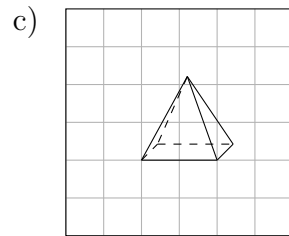
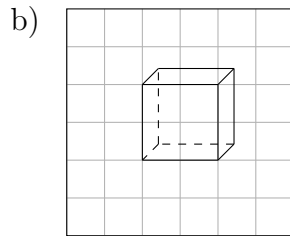
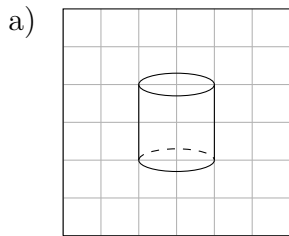

Good Luck!