

Worksheet

11/09/2019

Free on dw-math.com

Problem quickname: 1443

1)

Complete the shape by drawing the missing invisible lines. Use a dotted or dashed line.

a) Shape: A cuboid

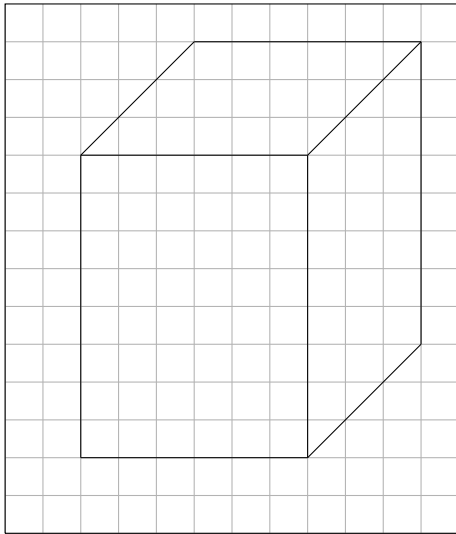

b) Shape: A cuboid

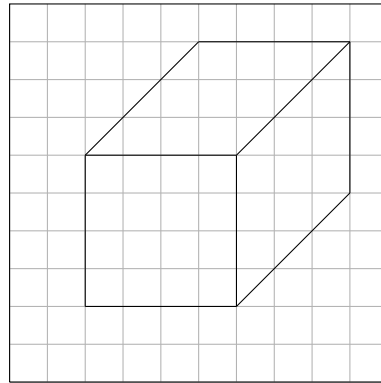

c) Shape: A pyramid

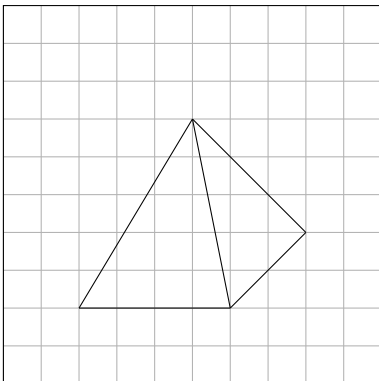

2)

Complete the shape by drawing the missing invisible lines. Use a dotted or dashed line.

line.

a) Shape: A tetrahedron

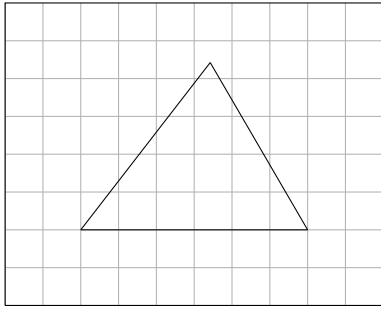

b) Shape: A pyramid

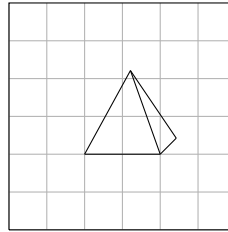

c) Shape: A cylinder

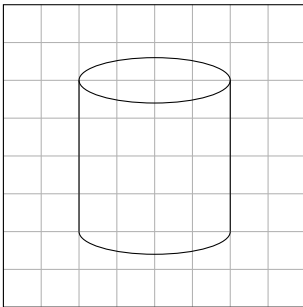

d) Shape: A cone

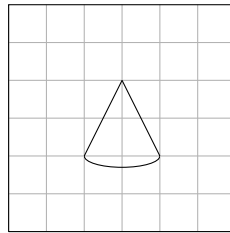

3)

Complete the shape by drawing the missing invisible lines. Use a dotted or dashed line.

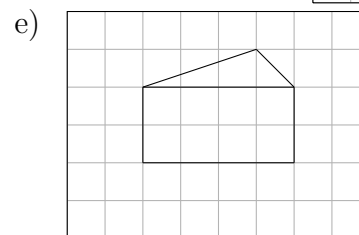
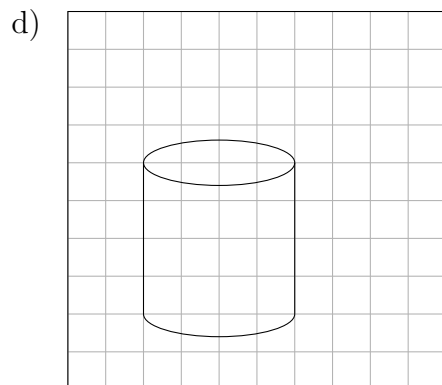
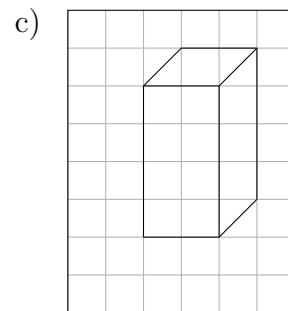
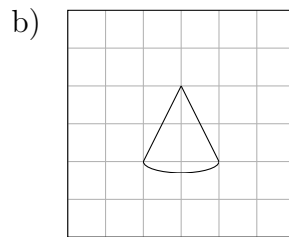
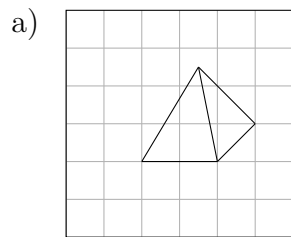

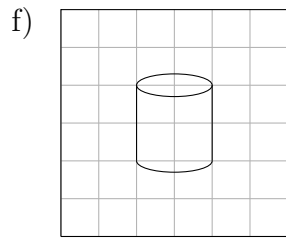

4)

Complete the shape by drawing the missing invisible lines. Use a dotted or dashed line.

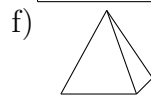
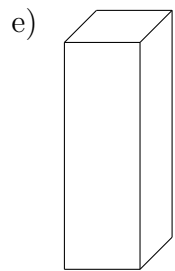
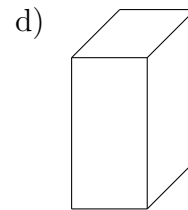
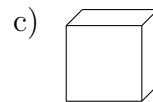
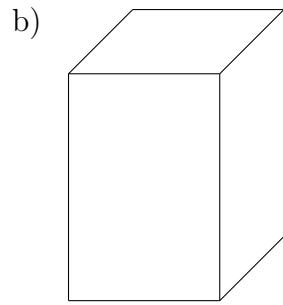
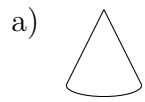

Good Luck!